

00258 00270 00271 00273 01466 01467
07880 27125 27837 27838 27839

$Q \leq 13 \text{ m}^3/\text{h}$

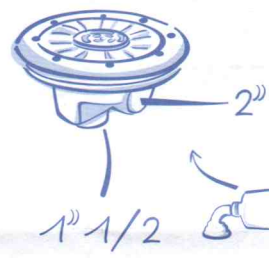

27814
 $Q \leq 11 \text{ m}^3/\text{h}$

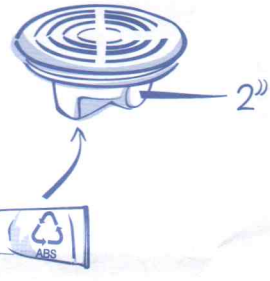

(b) EN 13541-1

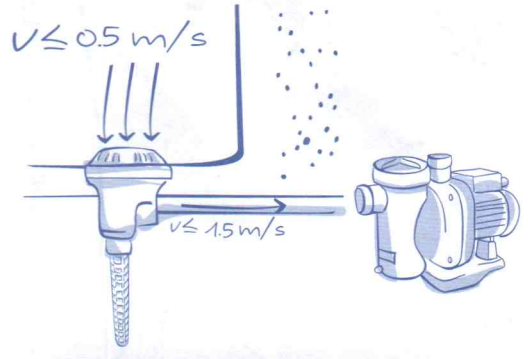

(c) EN 13541-1

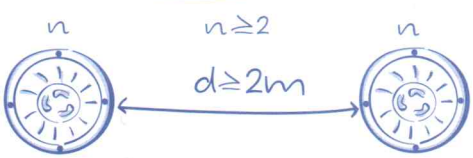

(d)

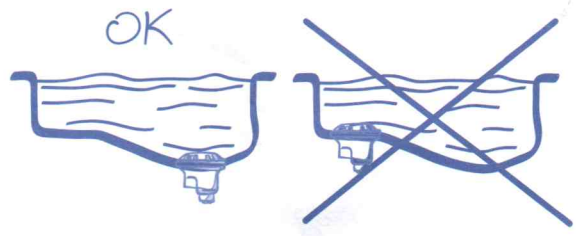

(e) 00258 00273

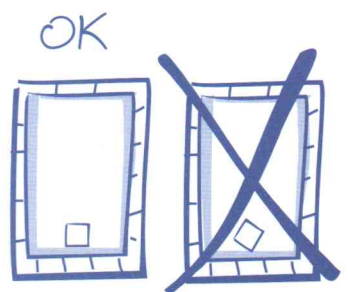

Concrete Pool

00258 01466 01467 27837 27839

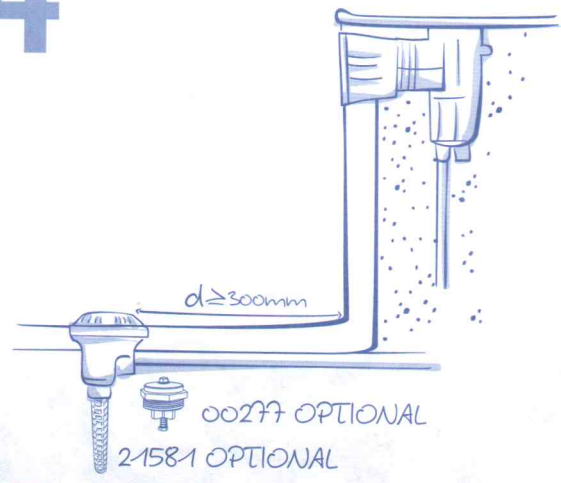

Polyester Pool

00270 00271 00273 07880 27125 27814 27838

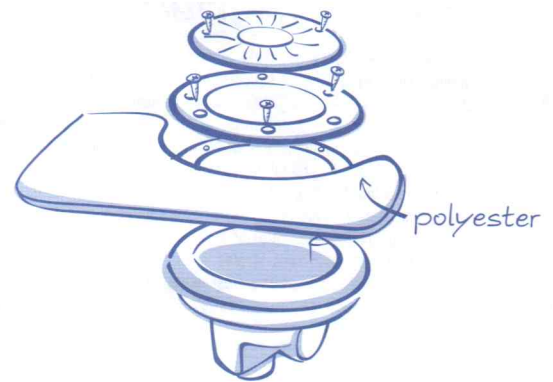

Concrete Pool with liner

00270 00271 00273 07880 27125 27814 27838

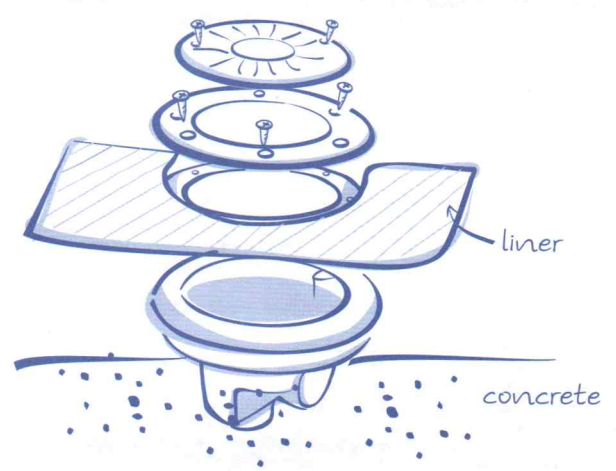

4

5

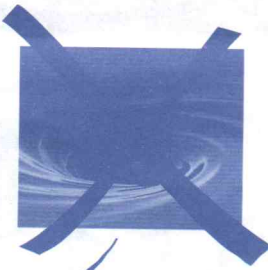

Antivortex



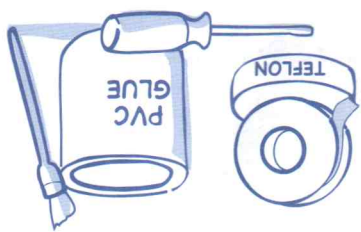

21581

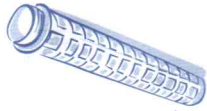

optional

00277



optional

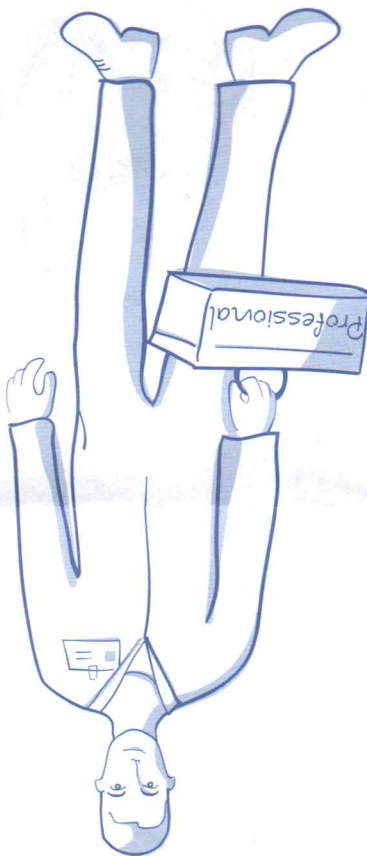

2

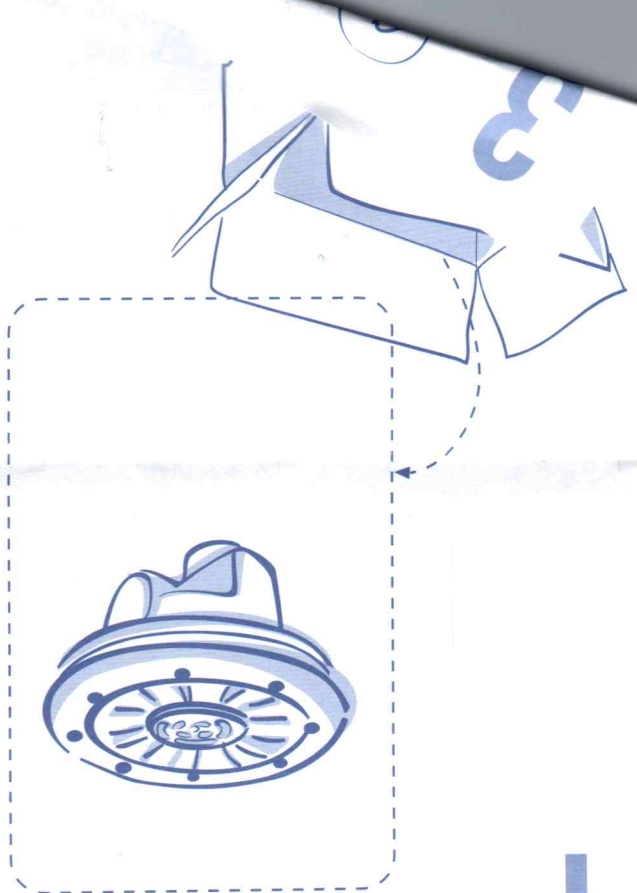

1

! WARNING - ATTENTION - ATENCIÓN - ATTENZIONE - ACHTUNG - ATENÇÃO

- The product supplied has ABS components, which could be damaged by chemical products. To glue them, only use glue specially formulated for PVC. Under no circumstances may the manufacturer be held liable for the use of other products such as adhesive sealants, fillers, silicone cements, etc.
- Certains éléments du produit fourni sont en plastique ABS, les produits chimiques peuvent donc l'endommager. Pour coller, veuillez utiliser exclusivement de colle de PVC, le fabricant ne sera en aucun cas tenu responsable de l'utilisation de tout autre produit utilisé comme adhésifs d'étanchéité, silicones, etc.
- El producto suministrado tiene componentes de plástico ABS y los productos químicos pueden dañarlo. Para encoladuras, utilizar solamente cola exclusiva de PVC, el fabricante en ningún caso se responsabiliza de la utilización de cualquier otro producto como adhesivos selladores, masillas, siliconas, etc..
- Alcuni dei componenti del prodotto fornito sono in plastica ABS, per cui i prodotti chimici possono danneggiarlo. Per eseguire lavori di incollaggio utilizzare esclusivamente colla per PVC. Il produttore non assume alcuna responsabilità in caso di utilizzo di qualsiasi altro prodotto, come ad es. adesivi sigillanti, stucchi, siliconi, ecc.
- Das gelieferte Produkt enthält ABS-Kunststoffkomponenten und kann durch Chemikalien geschädigt werden. Für Verklebungen darf nur spezieller PVC-Kleber verwendet werden; der Hersteller haftet unter keinen Umständen für die Verwendung jeglicher anderen Produkte wie Abdichtungskleber, Kitt, Silikon, usw.
- O produto fornecido tem componentes de plástico ABS, pelo que os produtos químicos podem danificá-lo. Para colagens, utilize apenas cola exclusivamente de PVC. O fabricante não se responsabilizará em caso algum pela utilização de quaisquer outros produtos, tais como colas vedantes, betumes, silicones, etc.
- Το παρεχόμενο προϊόν διαθέτει εξαρτήματα ABS, τα οποία μπορούν να υποστούν φθορά από τα χημικά προϊόντα. Για να τα κολλήσετε, χρησιμοποιήστε μόνο ειδικά σχεδιασμένη κόλλα για PVC. Ο κατασκευαστής δεν δύναται σε καμία περίπτωση να καταστεί υπεύθυνος για τη χρήση άλλων προϊόντων, όπως αυτοκόλλητα στεγανωτικά, υλικά πλήρωσης, στόκος σιλικόνης κ.λπ.

00258	00270	00271	00273	01466	01467	07880
27125	27814	27837	27838	27839		



Comercialized by: ASTRAL POOL S.A.U. NIF A-17583105. Avda. Francesc Macià, 60 - 08208 Sabadell, Barcelona, Spain. www.astralpool.com
Made by: NIF A-17092610

- We reserve the right to change all or part of the articles or contents of this document, without prior notice.
- Nos nous réservons le droit de modifier totalment ou en partie les caractéristiques de nos articles ou de le contenu de ce document sans pré-avis.
- Nos reservamos el derecho de cambiar total o parcialmente las características de nuestros artículos o contenido de este documento sin previo aviso.
- Ci riserviamo il diritto, senza preavviso, di cambiare, totalmente o parzialmente, il contenuto di questo documento.
- Wir behalten uns das recht vor die merkmale unserer produkte und den inhalt dieser beschreibung ohne vorherige ankündigung ganz oder teilweise zu ändern.
- Reservamo-nos ao direito de alterar, total ou parcialmente as características dos nossos artigos ou o conteúdo deste documento sem aviso prévio.
- Διατηρούμε το δικαίωμα τροποποίησης μέρους ή ολόκληρων των άρθρων ή των περιεχομένων αυτού του εγγράφου, χωρίς πρότερη ειδοποίηση.

27125E201-04